

Article number: 2310308011ESD

Description: E+G Antistatic base for levelling elements
LV.A-70-14-AS-M8x68-ESD-C

Measures

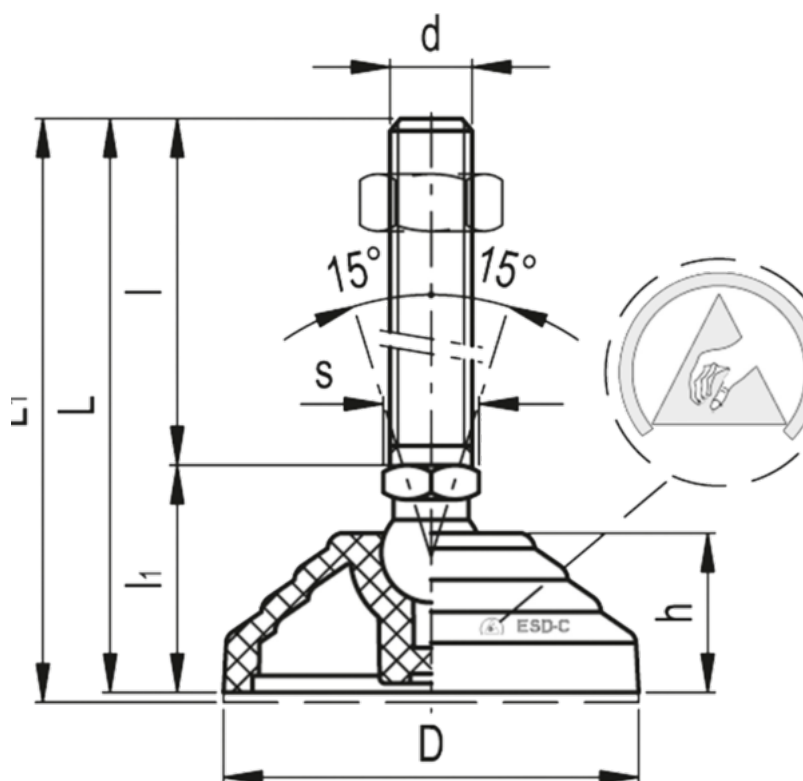

Articulation	= 14	Max load	= 14000
D	= 70	s	= 14
d	= M8	Weight in (g)	= 92
h	= 19		
l	= 68		
l1	= 28		
L	= 96		
L1	= 99		